

FEATURES

- **V_{CC} Current (L/LL)**
 - Operating: 70mA/50mA
 - CMOS Standby: 100µA/10µA
- **Access Times**
 - 55/70/85
- **Single 5 Volts ±10% Power Supply**
- **Easy Memory Expansion Using \overline{CE} and \overline{OE} Inputs**
- **Common Data I/O**
- **Three-State Outputs**
- **Fully TTL Compatible Inputs and Outputs**
- **Advanced CMOS Technology**
- **Automatic Power Down**
- **Packages**
 - 28-Pin 600 mil DIP
 - 28-Pin 300 mil Cerdip
 - 28-Pin 300 mil Narrow Body SOP
 - 28-Pin 330 mil SOP
 - 28-Pin LCC (350x550mil)
 - 32-Pin LCC (450x550mil)



DESCRIPTION

The P4C1256L/LL is an asynchronous 262,144-bit low power CMOS static RAM organized as 32Kx8. The CMOS memory requires no clocks or refreshing, and has equal access and cycle times. Inputs are fully TTL-compatible. The RAM operates from a single 5V±10% tolerance power supply.

Access times of 55 ns and 70 ns are available. CMOS is utilized to reduce power consumption to a low level.

Memory locations are specified on address pins A₀ to A₁₄.

Reading is accomplished by device selection (\overline{CE}) and output enabling (\overline{OE}) while write enable (\overline{WE}) remains HIGH. By presenting the address under these conditions, the data in the addressed memory location is presented on the data input/output pins. The input/output pins stay in the HIGH Z state when either \overline{CE} or \overline{OE} is HIGH or \overline{WE} is LOW.

The P4C1256LL device is a very low power version.



FUNCTIONAL BLOCK DIAGRAM

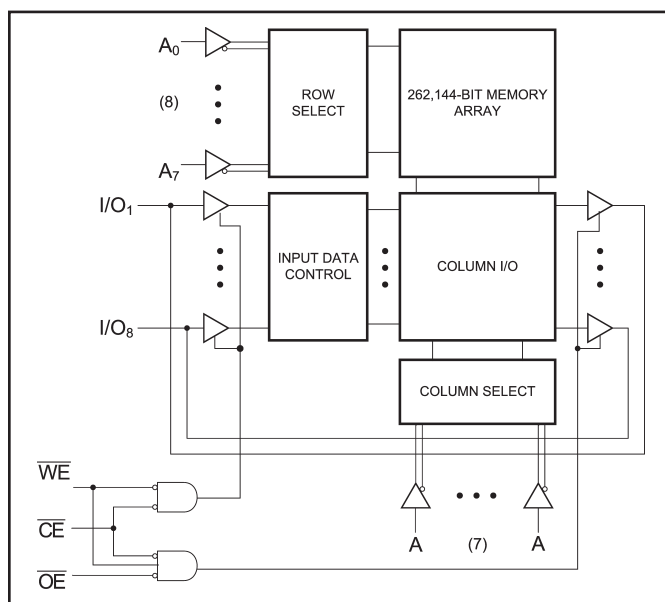

PIN CONFIGURATIONS

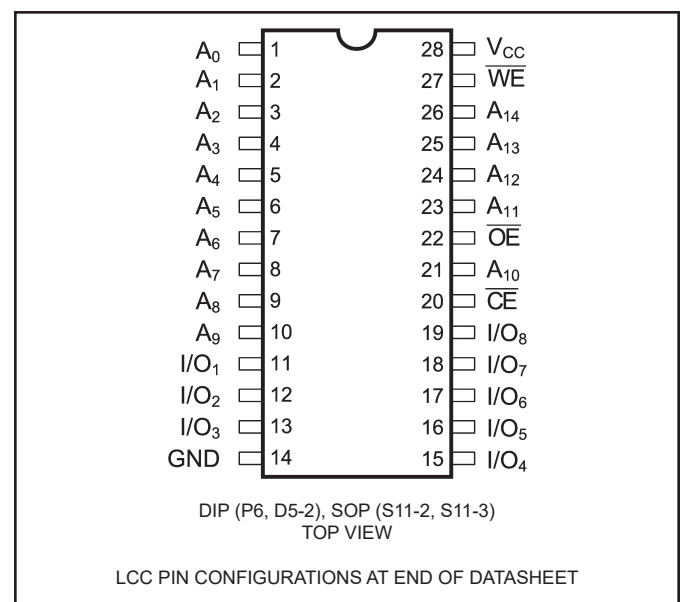



RECOMMENDED OPERATING TEMPERATURE AND SUPPLY VOLTAGE

Temperature Range (Ambient)	Supply Voltage
Commercial (0°C to 70°C)	$4.5V \leq V_{CC} \leq 5.5V$
Industrial (-40°C to 85°C)	$4.5V \leq V_{CC} \leq 5.5V$

MAXIMUM RATINGS⁽¹⁾

Sym	Parameter	Min	Max	Unit
V_{CC}	Supply Voltage with Respect to GND	-0.5	7.0	V
V_{TERM}	Terminal Voltage with Respect to GND (up to 7.0V)	-0.5	$V_{CC} + 0.5$	V
T_A	Operating Ambient Temperature	-55	125	°C
S_{TG}	Storage Temperature	-65	150	°C
I_{OUT}	Output Current into Low Outputs		25	mA
I_{LAT}	Latch-up Current	> 200		mA

DC ELECTRICAL CHARACTERISTICS

(Over Recommended Operating Temperature & Supply Voltage)⁽²⁾

Sym	Parameter	Test Conditions	Min	Max	Unit	
V_{OH}	Output High Voltage (I/O ₀ - I/O ₇)	$I_{OH} = -1mA, V_{CC} = 4.5V$	2.4		V	
V_{OL}	Output Low Voltage (I/O ₀ - I/O ₇)	$I_{OL} = 2.1mA$		0.4	V	
V_{IH}	Input High Voltage		2.2	$V_{CC} + 0.3$	V	
V_{IL}	Input Low Voltage		-0.5 ⁽³⁾	0.8	V	
I_{LI}	Input Leakage Current	$GND \leq V_{IN} \leq V_{CC}$	Com	-2	+2	μA
			Ind	-5	+5	
I_{LO}	Output Leakage Current	$GND \leq V_{OUT} \leq V_{CC}$ $\overline{CE} = V_{IH}$	Com	-2	+2	μA
			Ind	-5	+5	
I_{SB}	V_{CC} Current TTL Standby Current (TTL Input Levels)	$V_{CC} = 5.5V, I_{OUT} = 0 mA$ $\overline{CE} = V_{IH}$	L		3	mA
			LL		0.5	
I_{SB1}	V_{CC} Current CMOS Standby Current (CMOS Input Levels)	$V_{CC} = 5.5V, I_{OUT} = 0 mA$ $\overline{CE} \geq V_{CC} - 0.2V$	L		100	μA
			LL		10	

N/A = Not applicable

**CAPACITANCES⁽⁴⁾** $(V_{CC} = 5.0V, T_A = 25^{\circ}C, f = 1.0MHz)$

Symbol	Parameter	Test Conditions	Max	Unit
C_{IN}	Input Capacitance	$V_{IN}=0V$	7	pF
C_{OUT}	Output Capacitance	$V_{OUT}=0V$	9	pF

POWER DISSIPATION CHARACTERISTICS VS. SPEED

Sym	Parameter	Temperature Range	P4C1256L			P4C1256LL		Unit
			-55	-70	-85	-55	-70	
I_{CC}	Dynamic Operating Current*	Commercial	70	70	70	50	50	mA
		Industrial	85	85	85	50	50	mA

Tested with outputs open and all address and data inputs changing at the maximum write-cycle rate. The device is continuously enabled for writing, i.e. \overline{CE} and $\overline{WE} \leq V_{IL}(\text{max})$, \overline{OE} is high. Switching inputs are 0V and 3V.

AC ELECTRICAL CHARACTERISTICS—READ CYCLE

(Over Recommended Operating Temperature & Supply Voltage)

Sym	Parameter	-55		-70		-85		Unit
		Min	Max	Min	Max	Min	Max	
t_{RC}	Read Cycle Time	55		70		85		ns
t_{AA}	Address Access Time		55		70		85	ns
t_{AC}	Chip Enable Access Time		55		70		85	ns
t_{OH}	Output Hold from Address Change	5		5		5		ns
t_{LZ}	Chip Enable to Output in Low Z	5		5		5		ns
t_{HZ}	Chip Disable to Output in High Z		20		25		30	ns
t_{OE}	Output Enable Low to Data Valid		30		35		40	ns
t_{OLZ}	Output Enable Low to Low Z	5		5		5		ns
t_{OHZ}	Output Enable High to High Z		20		25		30	ns
t_{PU}	Chip Enable to Power Up Time	0		0		0		ns
t_{PD}	Chip Disable to Power Down Time		55		70		85	ns



TIMING WAVEFORM OF READ CYCLE NO. 1 (\overline{OE} CONTROLLED)⁽⁵⁾

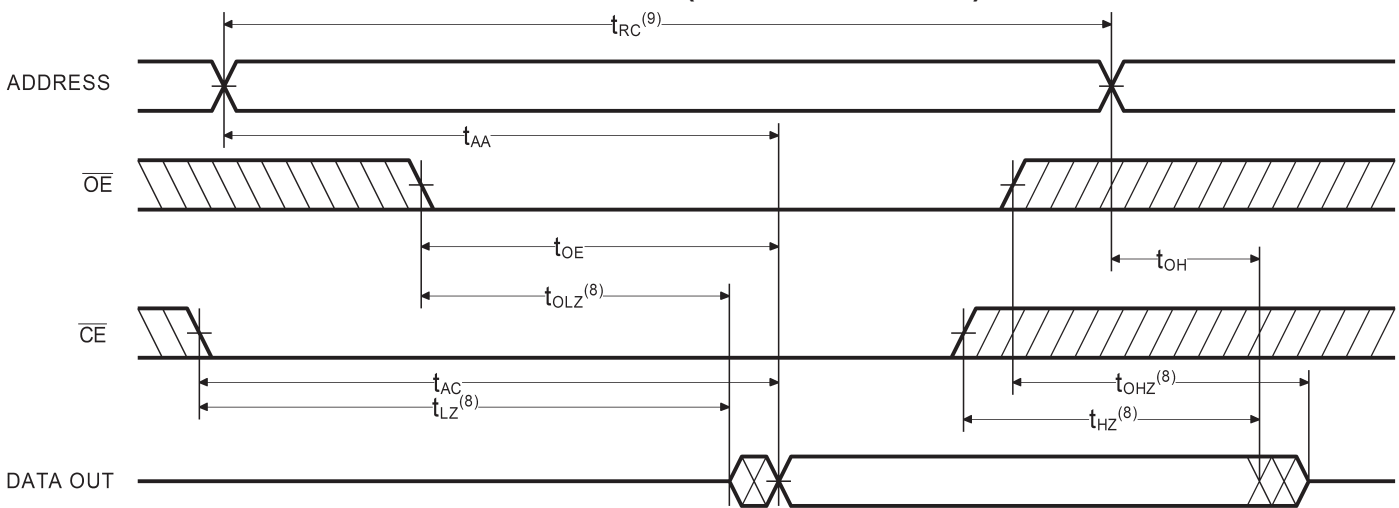

TIMING WAVEFORM OF READ CYCLE NO. 2 (ADDRESS CONTROLLED)^(5,6)

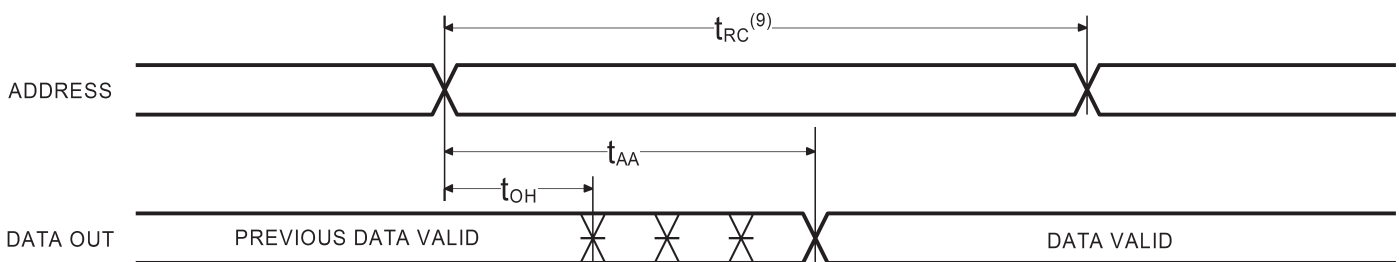

TIMING WAVEFORM OF READ CYCLE NO. 3 (ADDRESS CONTROLLED)^(5,7)

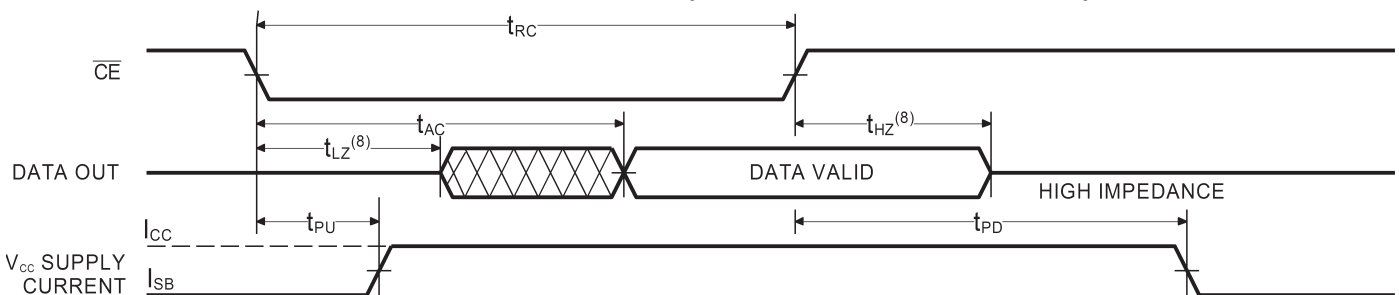

Notes:

- Stresses greater than those listed under MAXIMUM RATINGS may cause permanent damage to the device. This is a stress rating only and functional operation of the device at these or any other conditions above those indicated in the operational sections of this specification is not implied. Exposure to MAXIMUM rating conditions for extended periods may affect reliability.
- Extended temperature operation guaranteed with 400 linear feet per minute of air flow.
- Transient inputs with V_{IL} and I_{IL} not more negative than $-3.0V$ and $-100mA$, respectively, are permissible for pulse widths up to 20ns.
- This parameter is sampled and not 100% tested.
- \overline{WE} is HIGH for READ cycle.
- \overline{CE} is LOW and \overline{OE} is LOW for READ cycle.
- ADDRESS must be valid prior to, or coincident with \overline{CE} transition LOW.
- Transition is measured ± 200 mV from steady state voltage prior to change, with loading as specified in Figure 1. This parameter is sampled and not 100% tested.
- Read Cycle Time is measured from the last valid address to the first transitioning address.



AC CHARACTERISTICS—WRITE CYCLE

(Over Recommended Operating Temperature & Supply Voltage)

Symbol	Parameter	-55		-70		-85		Unit
		Min	Max	Min	Max	Min	Max	
t_{WC}	Write Cycle Time	55		70		85		ns
t_{CW}	Chip Enable Time to End of Write	50		60		75		ns
t_{AW}	Address Valid to End of Write	50		60		75		ns
t_{AS}	Address Setup Time	0		0		0		ns
t_{WP}	Write Pulse Width	40		50		60		ns
t_{AH}	Address Hold Time	0		0		0		ns
t_{DW}	Data Valid to End of Write	25		30		35		ns
t_{DH}	Data Hold Time	0		0		0		ns
t_{WZ}	Write Enable to Output in High Z		25		30		35	ns
t_{OW}	Output Active from End of Write	5		5		5		ns

TIMING WAVEFORM OF WRITE CYCLE NO. 1 (\overline{WE} CONTROLLED)^(10,11)

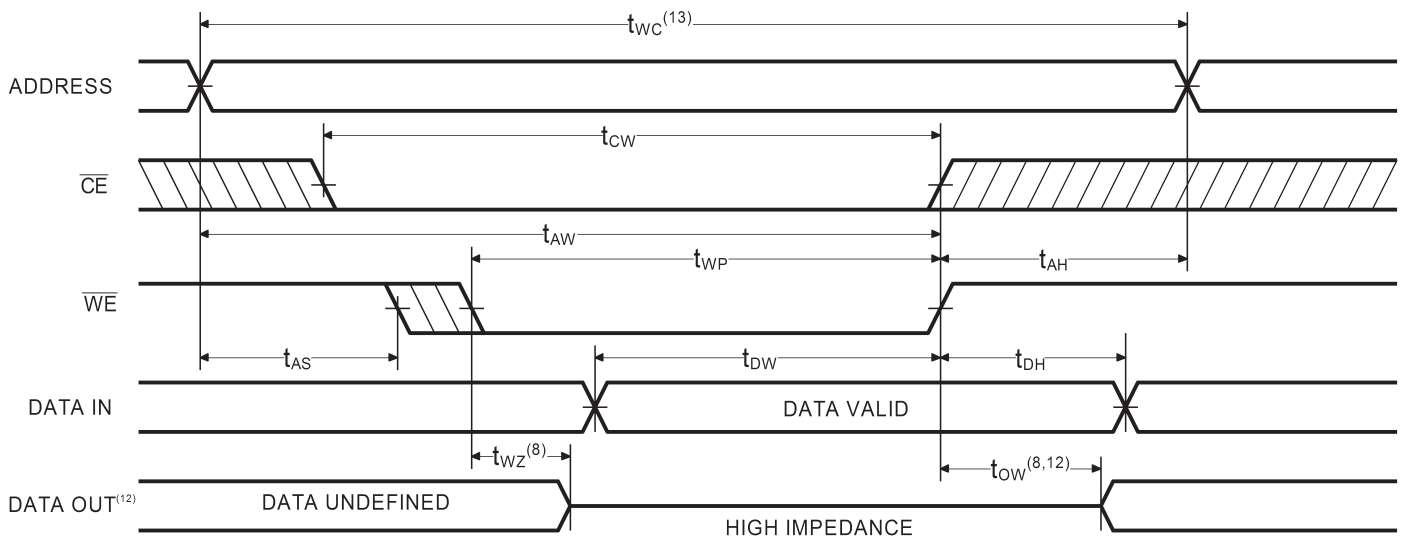

Notes:

- \overline{CE} and \overline{WE} must be LOW for WRITE cycle.
- \overline{OE} is LOW for this WRITE cycle to show t_{WZ} and t_{OW} .
- If \overline{CE} goes HIGH simultaneously with \overline{WE} HIGH, the output remains in a high impedance state.

- Write Cycle Time is measured from the last valid address to the first transitioning address.



TIMING WAVEFORM OF WRITE CYCLE NO. 2 (\overline{CE} CONTROLLED)⁽¹⁰⁾

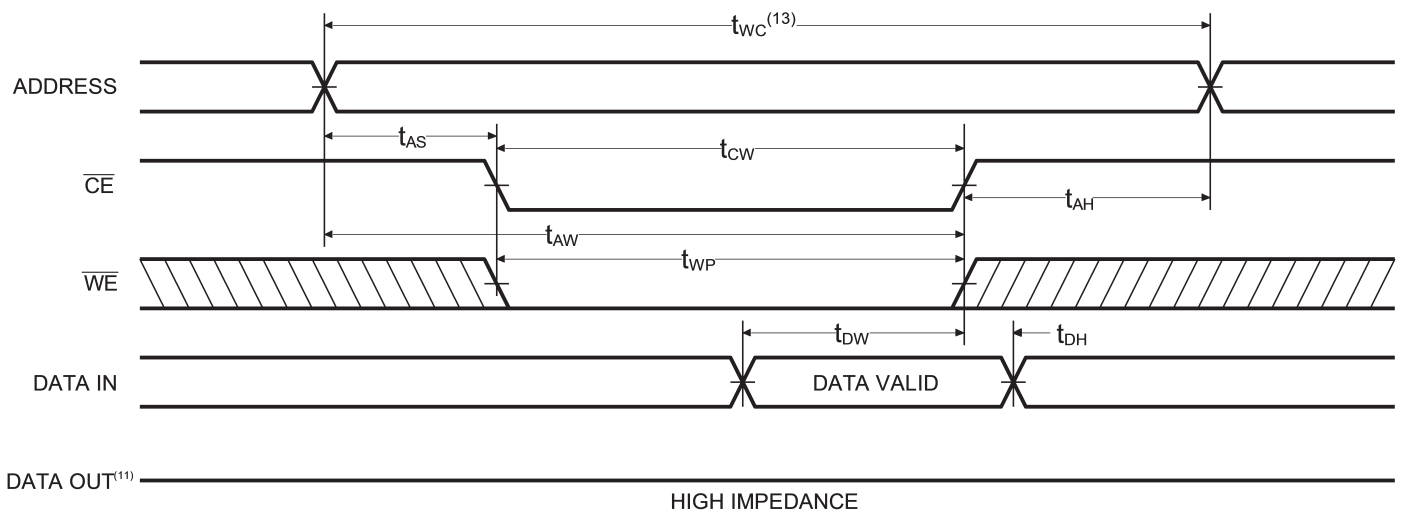

AC TEST CONDITIONS

Input Pulse Levels	GND to 3.0V
Input Rise and Fall Times	3ns
Input Timing Reference Level	1.5V
Output Timing Reference Level	1.5V
Output Load	See Figures 1 and 2

TRUTH TABLE

Mode	\overline{CE}	\overline{OE}	\overline{WE}	I/O	Power
Standby	H	X	X	High Z	Standby
Standby	X	X	X	High Z	Standby
D _{OUT} Disabled	L	H	H	High Z	Active
Read	L	L	H	D _{OUT}	Active
Write	L	X	L	High Z	Active

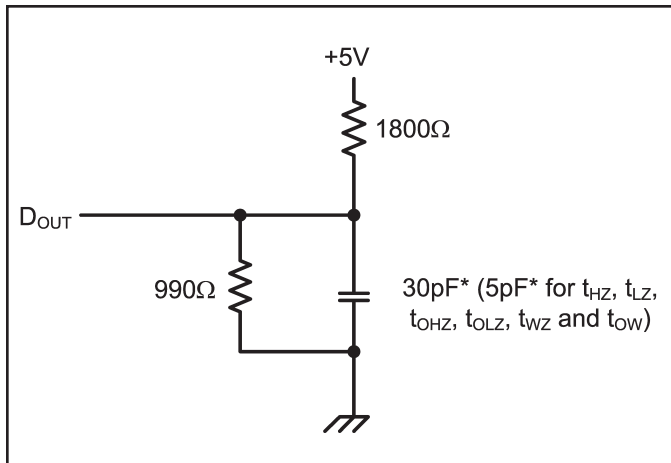

Figure 1. Output Load

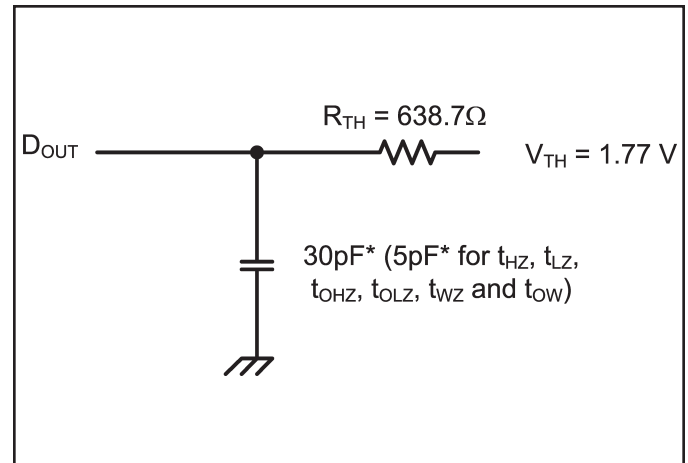

Figure 2. Thevenin Equivalent

* including scope and test fixture.

Note:

Because of the high speed of the P4C1256L, care must be taken when testing this device; an inadequate setup can cause a normal functioning part to be rejected as faulty. Long high-inductance leads that cause supply bounce must be avoided by bringing the V_{CC} and ground planes directly up to the contactor fingers. A 0.01 μF high frequency capacitor

is also required between V_{CC} and ground. To avoid signal reflections, proper termination must be used; for example, a 50Ω test environment should be terminated into a 50Ω load with 1.77V (Thevenin Voltage) at the comparator input, and a 589Ω resistor must be used in series with D_{OUT} to match 639Ω (Thevenin Resistance).



DATA RETENTION CHARACTERISTICS

Sym	Parameter	Test Conditions	Min	Typ.* V _{CC} =		Max V _{CC} =		Unit
				2.0V	3.0V	2.0V	3.0V	
V _{DR}	V _{CC} for Data Retention		2.0					V
I _{CCDR}	Data Retention Current	$\overline{CE} \geq V_{CC} - 0.2V,$ $V_{IN} \geq V_{CC} - 0.2V$ or $V_{IN} \leq 0.2V$	L	10	15	80	120	μA
			LL	0.1	0.2	10	20	
t _{CDR}	Chip Deselect to Data Retention Time		0					ns
t _R [†]	Operation Recovery Time		t _{RC} [§]					ns

* TA = +25°C

t_{RC}[§] = Read Cycle Time

† = This parameter is guaranteed but not tested.

DATA RETENTION WAVEFORM

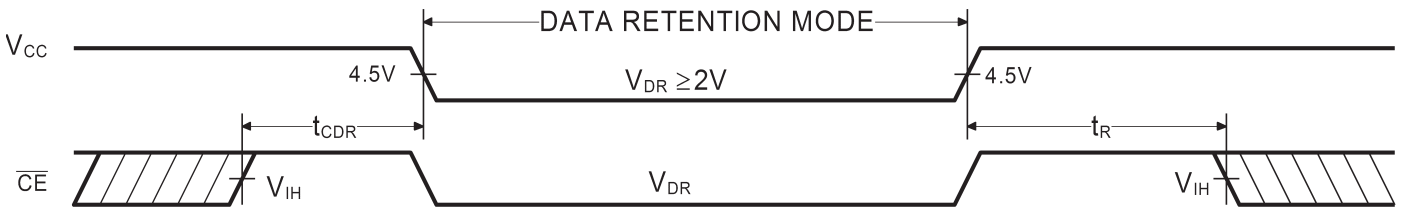

LCC PIN CONFIGURATIONS

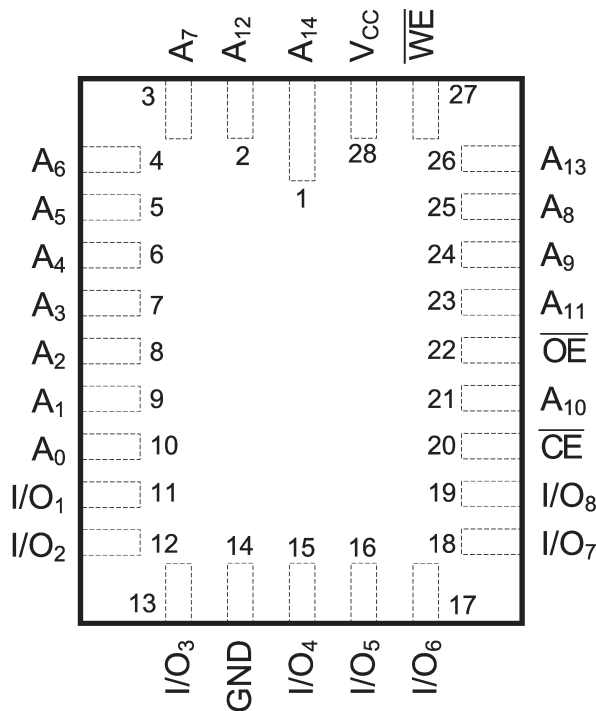

28-Pin LCC (L5)

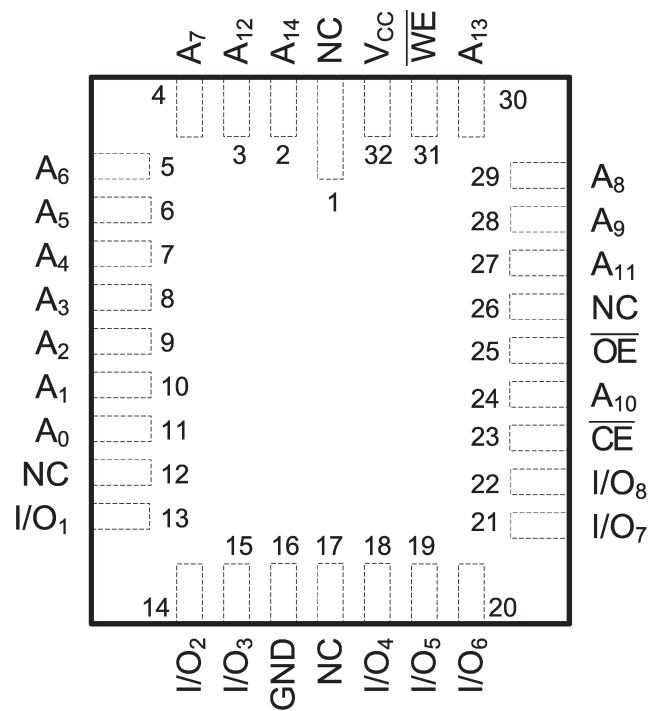

32-Pin LCC (L6)



ORDERING INFORMATION

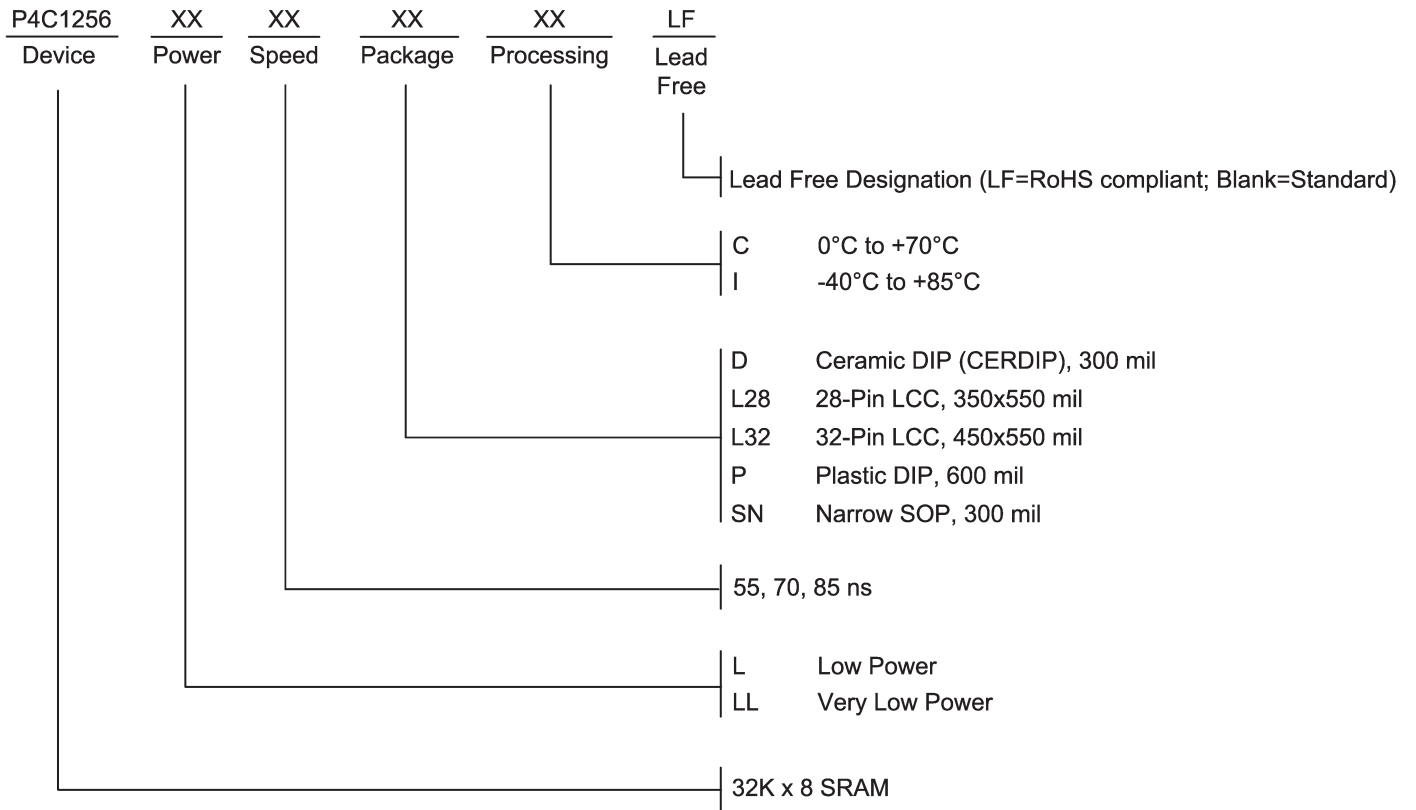



Pkg #	D5-2	
# Pins	28 (300 mil)	
Symbol	Min	Max
A	-	0.225
b	0.014	0.026
b2	0.045	0.065
C	0.008	0.018
D	-	1.485
E	0.240	0.310
eA	0.300 BSC	
e	0.100 BSC	
L	0.125	0.200
Q	0.015	0.060
S1	0.005	-

CERDIP DUAL IN-LINE PACKAGE

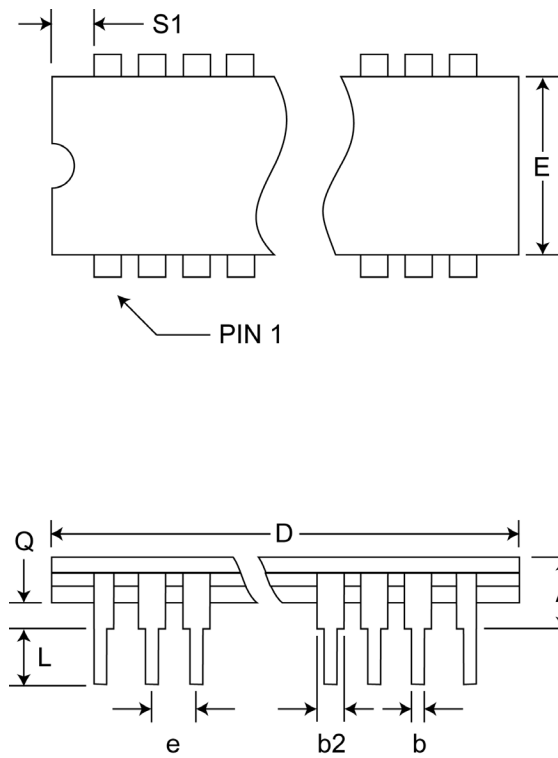

Pkg #	L5	
# Pins	28	
Symbol	Min	Max
A	0.060	0.075
A1	0.050	0.065
B1	0.022	0.028
D	0.342	0.358
D1	0.200 BSC	
D2	0.100 BSC	
D3	-	0.358
E	0.540	0.560
E1	0.400 BSC	
E2	0.200 BSC	
E3	-	0.558
e	0.050 BSC	
h	0.040 REF	
j	0.020 REF	
L	0.045	0.055
L1	0.045	0.055
L2	0.075	0.095
ND	5	

RECTANGULAR LEADLESS CHIP CARRIER

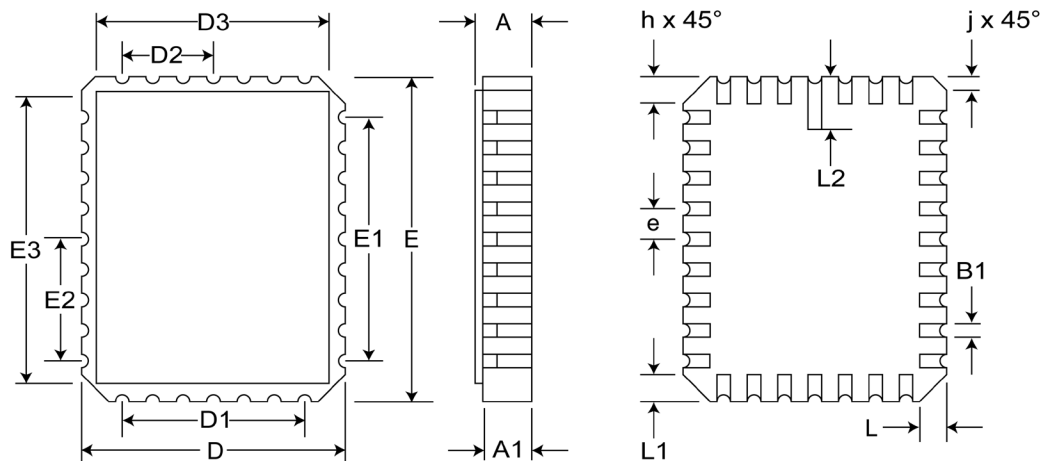



RECTANGULAR LEADLESS CHIP CARRIER

Pkg #	L6	
# Pins	32	
Symbol	Min	Max
A	0.060	0.075
A1	0.050	0.065
B1	0.022	0.028
D	0.442	0.458
D1	0.300 BSC	
D2	0.150 BSC	
D3	-	0.458
E	0.540	0.560
E1	0.400 BSC	
E2	0.200 BSC	
E3	-	0.558
e	0.050 BSC	
h	0.040 REF	
j	0.020 REF	
L	0.045	0.055
L1	0.045	0.055
L2	0.075	0.095
ND	7	

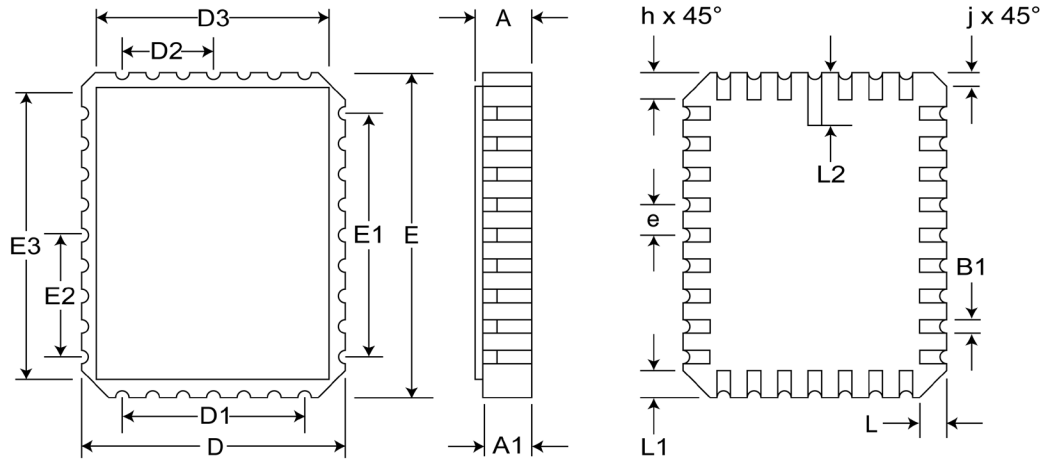

Pkg #	P6	
# Pins	28 (600 mil)	
Symbol	Min	Max
A	0.090	0.200
A1	0.000	0.070
b	0.014	0.020
b2	0.015	0.065
C	0.008	0.012
D	1.380	1.480
E1	0.485	0.550
E	0.600	0.625
e	0.100 BSC	
eB	0.600 TYP	
L	0.100	0.200
α	0°	15°

PLASTIC DUAL IN-LINE PACKAGE

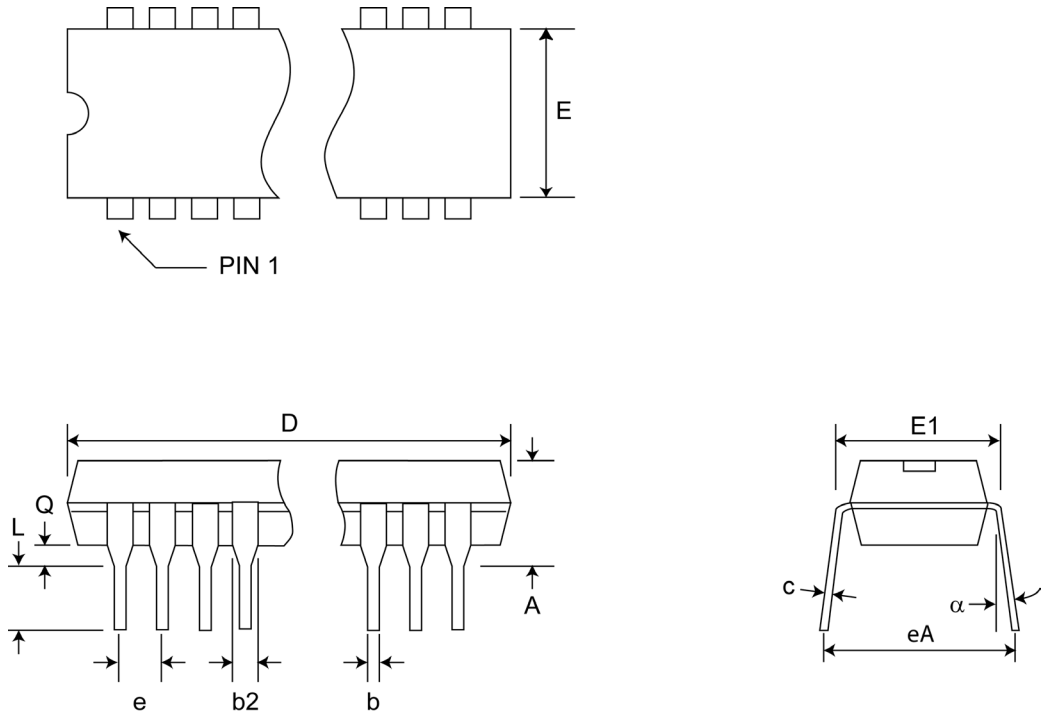



Pkg #	S11-2	
# Pins	28 (330 Mil)	
Symbol	Min	Max
A	-	0.112
A1	0.004	-
b2	0.014	0.020
C	0.008	0.014
D	0.693	0.733
e	0.050 BSC	
E	0.321	0.341
H	0.453	0.477
h	0.010	0.029
L	0.028	0.044
α	0°	8°

SOIC/SOP SMALL OUTLINE IC PACKAGE

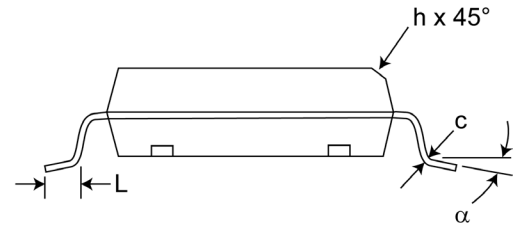
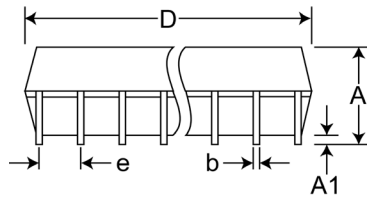
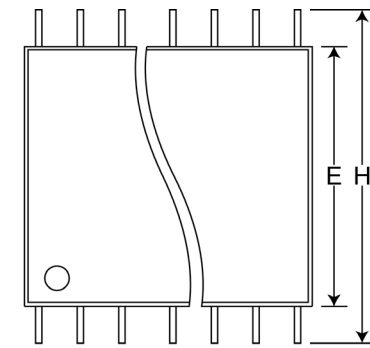

Pkg #	S11-3	
# Pins	28 (300 Mil)	
Symbol	Min	Max
A	0.094	0.110
A1	0.002	0.014
B	0.014	0.020
C	0.008	0.012
D	0.702	0.710
e	0.050 BSC	
E	0.291	0.300
H	0.463	0.477
h	0.010	0.029
L	0.020	0.042
α	0°	8°

SOIC/SOP SMALL OUTLINE IC PACKAGE

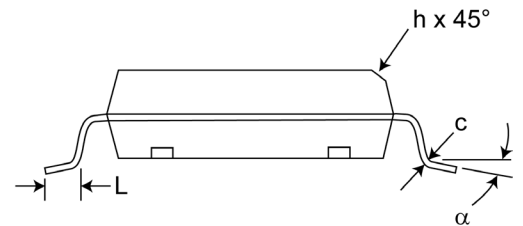
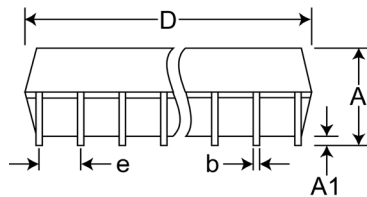
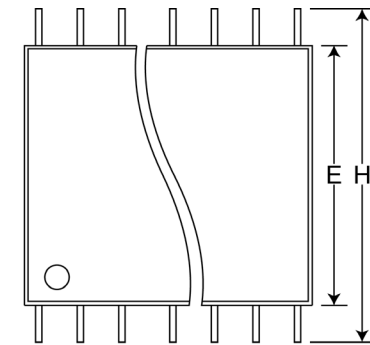

**REVISIONS**

DOCUMENT NUMBER	SRAM121
DOCUMENT TITLE	P4C1256L/P4C1256LL LOW POWER 32K x 8 STATIC CMOS RAM

REV	ISSUE DATE	ORIGINATOR	DESCRIPTION OF CHANGE
OR	1997	DAB	New Data Sheet
A	Oct-2005	JDB	Changed logo to Pyramid
B	Jun-2006	JDB	Added 28-pin ceramic DIP
C	Aug-2006	JDB	Added Lead Free designation
D	Mar-2007	JDB	Corrected Narrow SOP width in Ordering Information and Selection Guide
E	Jun-2007	JDB	Corrected Narrow SOP package dimensions
F	Sep-2010	JDB	Added 28-pin and 32-pin LCC packages
G	Jul-2012	JDB	Added 28-pin 330 mil SOP
H	Jun-2018	JDB	Added P4C1256LL